

Hisense

AIR TO WATER HEAT PUMP

Hisense

Qingdao Hisense HVAC Equipment Co., Ltd.
Hisense Tower, Qingdao, China

<http://www.hisense-vrf.com> export@hisensehitachi.com [@HisenseVRFGlobal](#) [Hisense VRF](#) [Hisense VRF](#)



HCAC-CA-ATW202201

★ Design and specifications are subject to change without notice. Pictures and diagrams are for reference only and are subject to change without notice.
All rights reserved by Qingdao Hisense HVAC Equipment Co., Ltd.



Hi-Therma
Hi-Aquasmart

Reimagine your solution

GLOBAL HISENSE SINCE 1969

Hisense Group is a well-known large-scale electronic information industry group company. Based on technology and focusing on innovation-oriented culture, its scientific and efficient technological innovation system makes Hisense always be at the forefront of the counterparts. So far, Hisense has 16 production bases, 16 R&D centers and 12 Hisense CAC branches all over the world.



Official Sponsor of the Australian Open

Team Supplier to Red Bull Racing

Official Partner of UEFA EURO 2016



Official Sponsor of the 2018 FIFA World Cup

Official Partner of UEFA EURO 2020

Official Sponsor of the 2022 FIFA World Cup





266,000 m²
Manufacturing Area



40+
Production Line



6,000,000 units/year
Production Capacity



16,700 m²/70+
Laboratory

Hisense CAC MANUFACTURING BASE

Qingdao Hisense HVAC Equipment Co., Ltd. is a wholly owned subsidiary of Qingdao Hisense Hitachi Air-conditioning Systems Co., Ltd., who is a joint-venture of Hisense and Hitachi (changed to Johnson Control Hitachi in 2015) and was established in 2003.

It integrates technology development for commercial and residential central air conditioners, product manufacturing, marketing and service as a whole. With the full support of all the shareholders such as Hisense and Johnson Control Hitachi, Hisense CAC is committed to becoming the market leader in the industry.

The best is always yet to come. We are constantly devoted ourselves to supply excellent products and service to our customers.



Air to Water Heat Pump System

ATW heat pump system is a ground breaking low energy system for cooling, heating and domestic hot water production, which delivers outstanding performance, even at extreme outdoor temperatures.

Absolute comfort with
efficient and eco-friendly operation



CONTENTS

Heat Pump System Profile

Hi-Therma

Hi-Aquasmart

Accessories&Engineering Tools

01

07

47

59



Heat Pump System Profile

ATW heat pump system is a new generation of heating solutions that use a renewable, free energy source (the air) to heat or cool the home and to produce hot water.





What's Heat Pump System?

The heat pump system is a device that transforms energy from the air, the soil and the water to useful heat. Compared with the conventional electrical heater and fossil fuel heater, the system is more energy-efficient, eco-friendly.

Thanks to the heat pump technology, the air to water heat pump system can be driven by a small amount of electric energy, extract renewable heat from the outside air, and then supply a large amount of heat to your home. The heat output is greater than the electricity input, thus the system is extremely high efficiency.

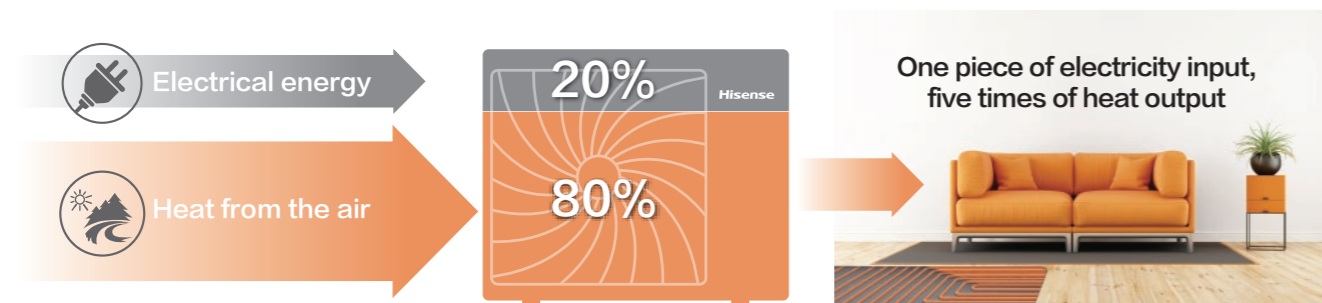

Prior to this, traditional heating systems mainly used fuels such as gas, oil, and coal but these fuels easily cause environmental pollution, emit large amounts of carbon dioxide into the air, and cause global climate changes. The air source heat pump system effectively reduces environmental pollution while maintaining high energy efficiency.



Conventional Boiler



Air to Water Heat Pump



VS

How do Air to Water Heat Pumps Work?

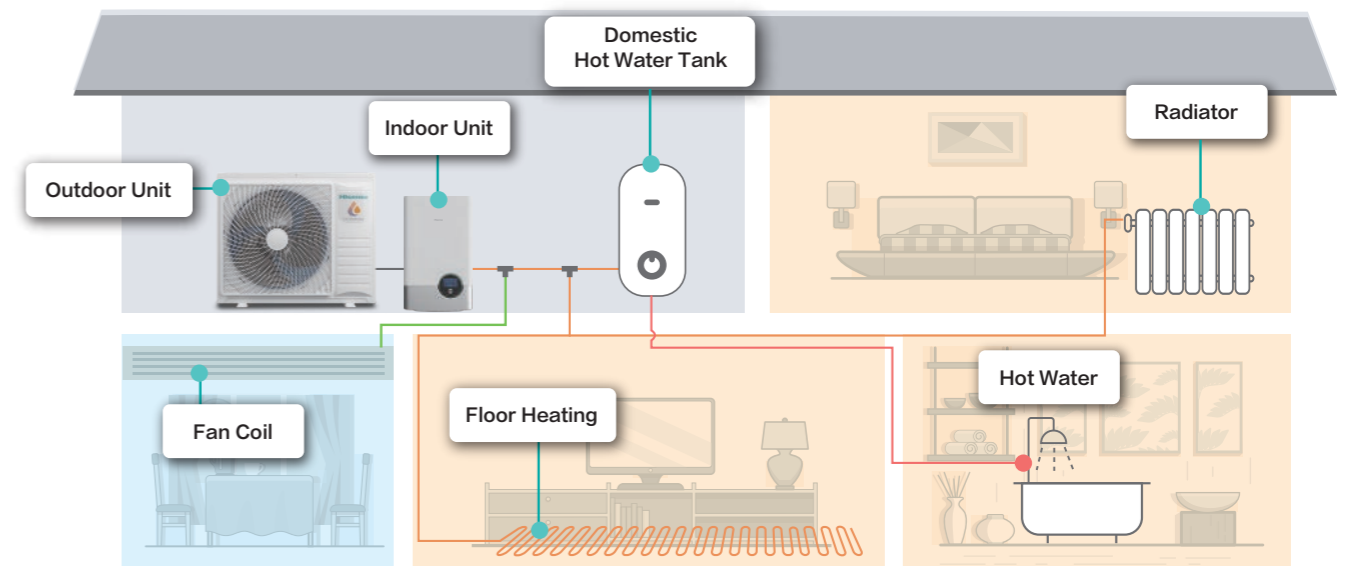

Regulations and Certifications

AIR TO WATER
HEAT PUMP



F-Gas Regulation

European regulation F-GAS (517/2014) came into force on 1st January 2015, in order to reduce greenhouse gas emissions. It aims to reduce the environmental impact of F-gases through the reduction of the amount of HFC (hydrofluorocarbon) refrigerant used in cooling and heating systems.

The regulation 517/2014 prescribes a phase-down of HFCs, where the quantities of HFCs that are placed on the market are gradually reduced through the allocation of quotas by the European Commission. The phase-down targets are expressed in CO₂ equivalents (= kg x GWP- Global Warming Potential) and aim to reduce HFC consumption by 79% in 2030.

Consumption of HFC compared to CO₂ equivalent tonnes

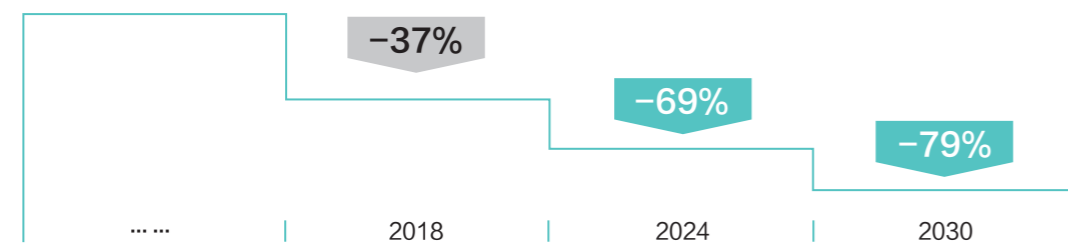

KEYMARK Certificate

The Heat Pump KEYMARK is a voluntary, independent European certification mark (ISO type 5 certification) for all heat pumps, combination heat pumps and hot water heaters (as covered by Ecodesign, EU Regulation 813/2013 and 814/2013).

It is based on independent, third party testing and demonstrates compliance with product requirements as set in the Heat Pump KEYMARK scheme rules and with efficiency requirements as set by Ecodesign.

The Heat Pump KEYMARK scheme is owned by the European Committee for standardization (CEN). The certificates are granted by independent Certification Bodies to products fulfilling all requirements of the scheme.

Check all our certified heat pumps on: www.heatpumpkeymark.com





Hi-Therma Series



Product Lineup Overview

Series	Hi-Therma	
Type	Split	Monobloc
Diagram		
Refrigerant Type	R32	R32
Line-up	4.4/6.0/8.0kW	4.4/8.0kW
Application		
Energy Label Space Heating 35°C	A+++	A+++
Energy Label Space Heating 55°C	A++	A++
Benefit	<ul style="list-style-type: none"> A+++ energy efficiency Stable heating under -25°C 60°C leaving water Two separate temp. cycles Smart APP control Visual display of energy consumption Centralized control for different water cycles and individual control for rooms Suitable for different complex application scenarios 	<ul style="list-style-type: none"> A+++ energy efficiency Stable heating under -25°C 60°C leaving water Two separate temp. cycles Smart APP control Visual display of energy consumption Centralized control for different water cycles and individual control for rooms Suitable for different complex application scenarios Easy installation without refrigerant operation



Features Overview



High Efficiency and Excellent Performance



R32 Eco-friendly refrigerant

Adopting refrigerant R32 show a drastic reduction in the value of Global Warming Potential (GWP).



A+++ energy efficiency

Energy efficiency class up to A+++ in a scale from A+++ to D, with better efficiency & value for low temperature applications.



Interlock with 3rd party heat source

Can be interlocked with the solar thermal system and the boiler.



-25°C stable operation

Achieve stable operation even under extremely low temperature -25°C.



60°C leaving water

Up to 60°C leaving water can be produced by the indoor unit



75°C domestic hot water

Max. 75°C hot water can be generated in the water tank, achieving sterilization.



Smart grid interlock and PV enabled

The system's potential can be maximised by connecting to Smart Grid or PV.



High-efficiency DC pump

It is featured with water flow monitoring, achieving variable water flow control.

High Intelligence



Smart App control

Remotely control the system anytime and anywhere.



Intuitive interface of controllers

Easy to understand and convenient to control.



Smart hint

The intuitive light strip in the indoor unit shows you in real time the status of your system.

User Convenience



Two separate temp. cycles

Achieve different water temp. for the floor heating and radiators.



Up to 7 rooms with independent temp. control

Max. 7 rooms independent control with our room thermostat and wall mounted temp. sensor.



Low noise operation

This function can be activated through the controller conveniently.



Night shift mode operation

Night shift mode can be set freely.



Centralized control and individual control

Centralized control for different water cycles and individual control for max. 7 rooms.



Screed drying

An automatic program for drying out the screed during the construction of a house.



Swimming pool heating

Available for the swimming pool and with the lowest priority of the system.



Visual display of energy consumption

Energy consumption can be accessed through the controllers.

Easy Installation and Maintenance



Hi-Checker

Intelligent service tool and easy to maintenance remotely.



Long piping design

Long piping length enables flexible design and easy installation.



No refrigerant piping

No need to install refrigerant pipes on site.



Water pressure and water flow monitoring

The water pressure and water flow can be monitored and displayed in real-time, convenient for commission.

High Efficiency and Excellent Performance



Eco-friendly Refrigerant R32

R32 refrigerant contributes to meeting the F-gas regulation targets as described in EU regulation 517/2014. Hisense Hi-Therma heat pump system adopts R32 refrigerant, which is a perfect solution for attaining the new European CO2 emission targets.

Features

- ◆ Zero Ozone Depletion Potential (ODP)
- ◆ Lower Global Warming Potential (GWP)
- ◆ Less charge amount under the same capacity
- ◆ Single component refrigerant, easy to handle and recycle

R-32

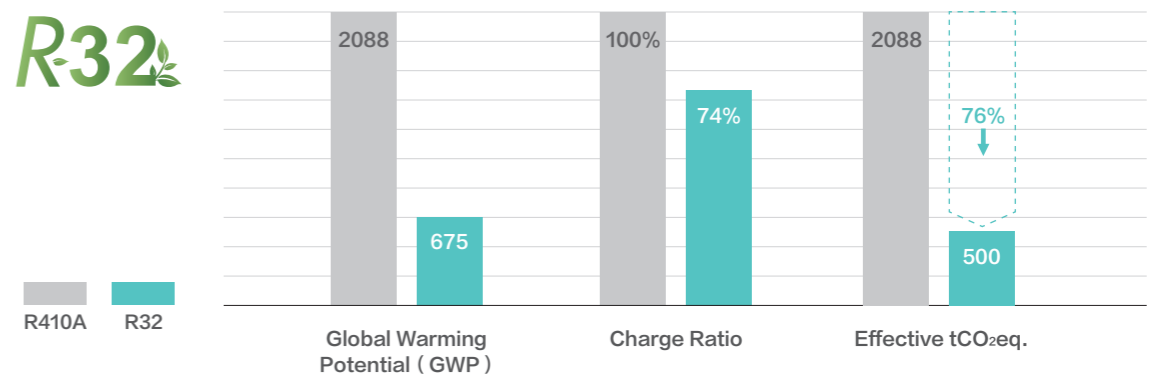

High Efficiency A+++

Hi-Therma offers the best and efficient solution for home heating and hot water supply. It has the top class A+++ energy classification under the low-temperature water condition, and A++ under the mid-temperature water condition, which ensures you make savings on your energy bills, reducing electricity consumption and the impact on the environment.



*Take AHW-060HCDS1, AHM-060HCDSAA as an example.

High-efficiency DC Inverter Compressor

A high-efficiency DC inverter twin rotary compressor is adopted. It features unique dual-pressure chamber design and symmetrical location, which can effectively reduce the vibration and noise and improve the compressor performance, especially the performance under low-frequency operation.

Moreover, the twin rotary compressor has a small lubricating oil injection volume with stable oil return, and comes with a gas-liquid separator, which makes the system more reliable.

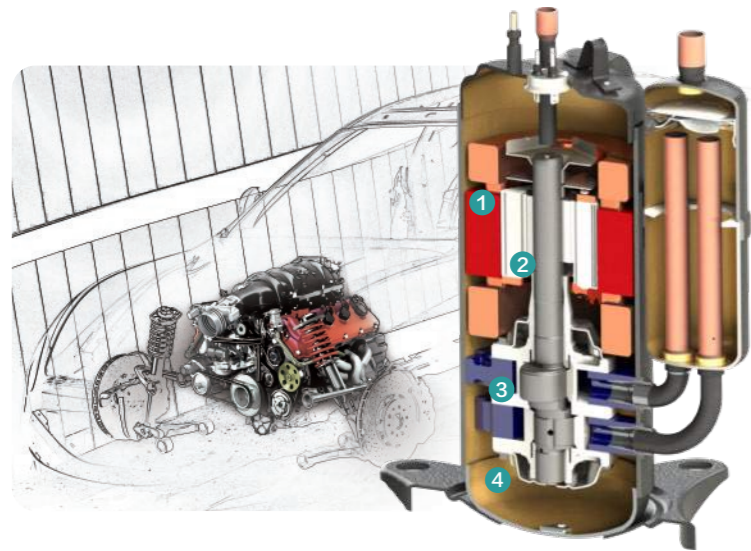

- 1 High-efficiency motor**
 Optimize the motor design to improve compressor performance.
- 2 Optimized rotor design**
 Lower the center of gravity of the compressor to reduce the noise and vibration.
- 3 Flat mechanism design**
 Improve the volumetric efficiency and the total performance.
- 4 Screw interactive fastening**
 Improve fastening effect and reduce deformation of the core.

Wide Operation Range

Stable operation is guaranteed, even with outdoor temperatures as low as -25°C , effectively satisfying the heating demand in extremely cold areas. It can generate up to 60°C leaving water from the indoor unit. Besides, the operation range of DHW is extended to 40°C , and the water inside the water tank can achieve max. 75°C with electric heater, enabling effective sterilization.

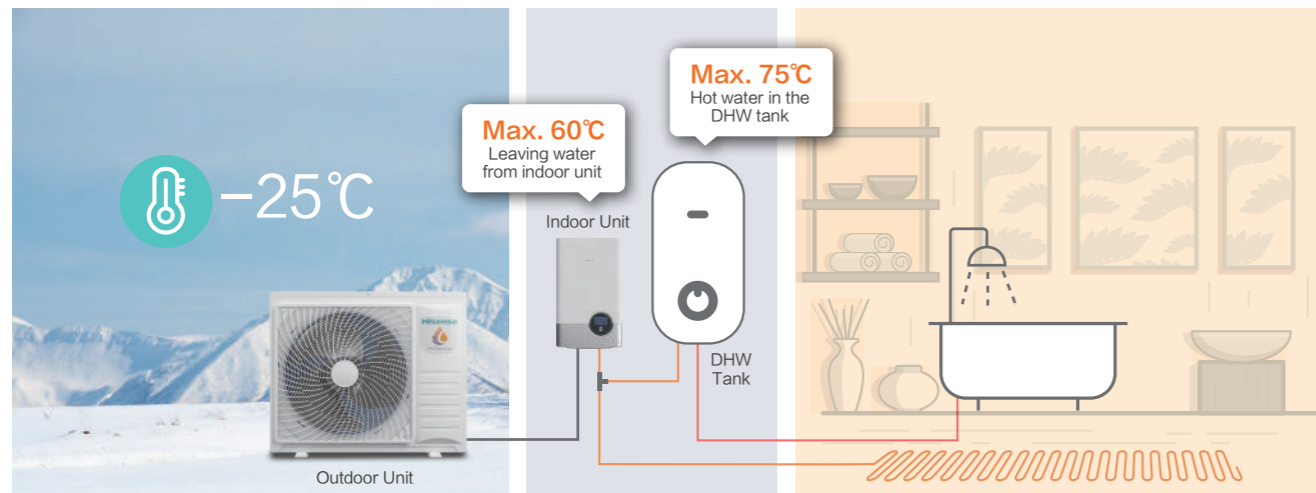

Interlock with 3rd Party Heat Source

Hi-Therma system can interlock with the 3rd party heat source, like the solar thermal or the boiler which can work as an auxiliary heat source. Thanks to the interlock design, both the user experience and energy efficiency can be optimized.

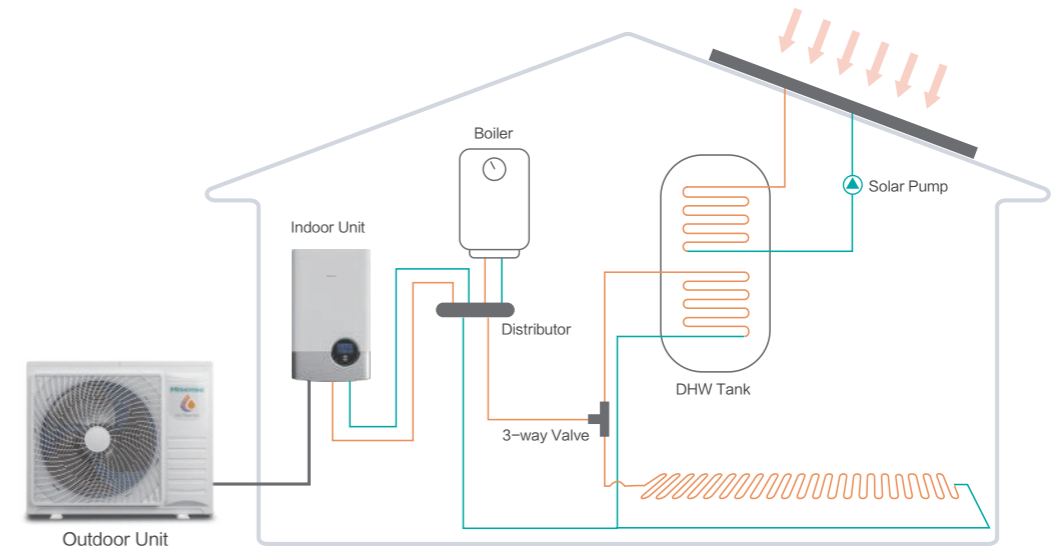

Smart Grid Interlock and PV Enabled

Hi-Therma system can be integrated into the smart grid, to achieve a low-cost operation required to meet carbon reduction targets. Also, the system can be integrated to the Photovoltaic(PV), saving energy through renewable sources. The system's potential can be maximised by connecting to Smart Grid or Photovoltaic(PV).

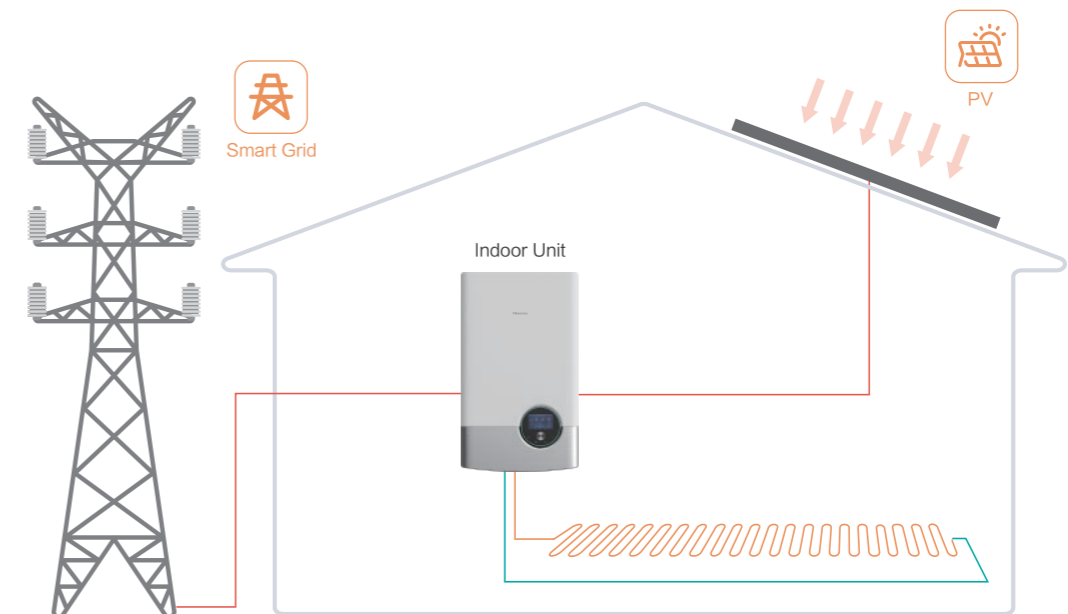

User Convenience

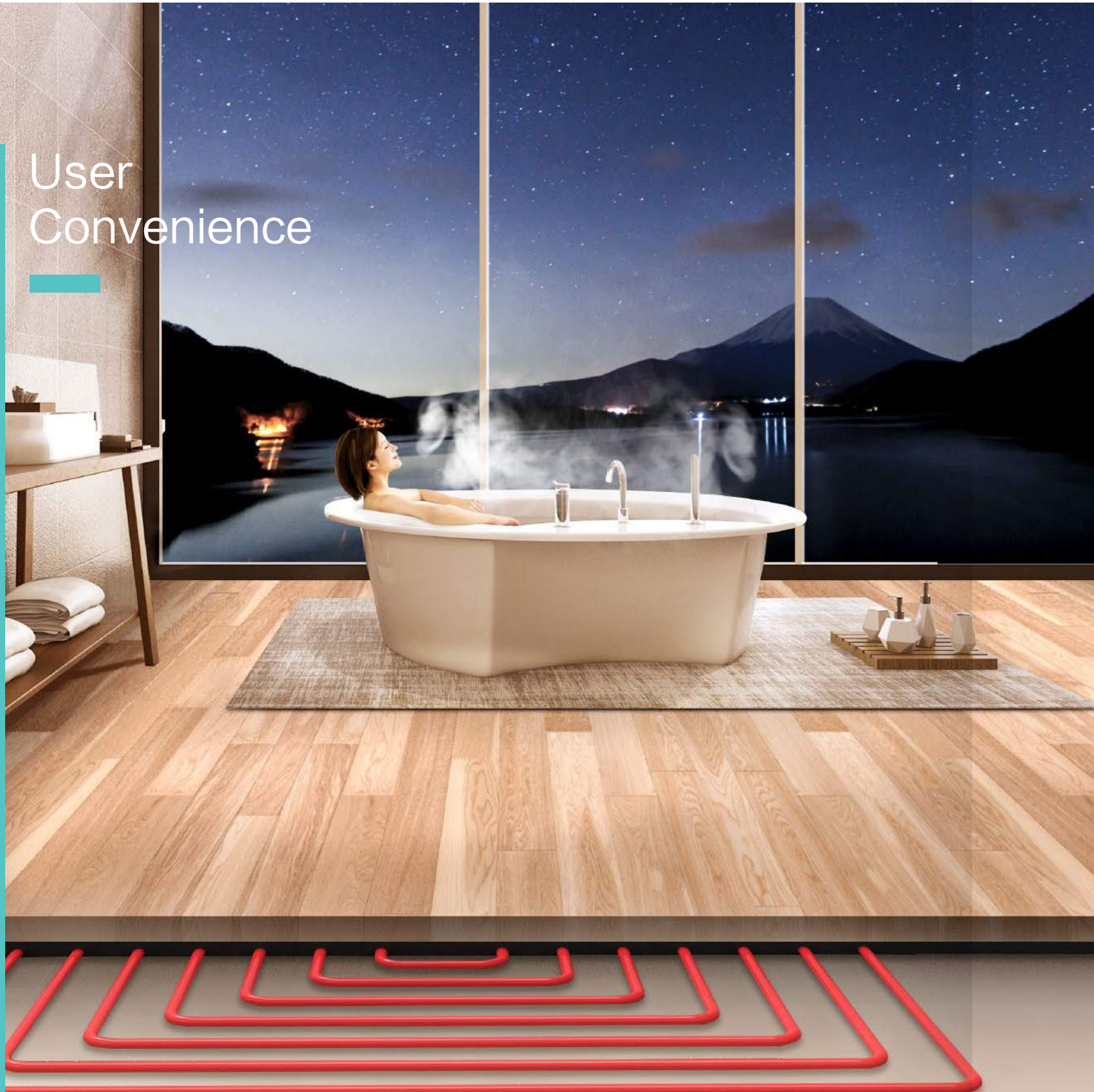

Two Separate Temperature Cycles

Two temperature zones through the separate heating cycles is possible with the mixing valve kit, enabling different water temperatures for underfloor heating and the radiator.

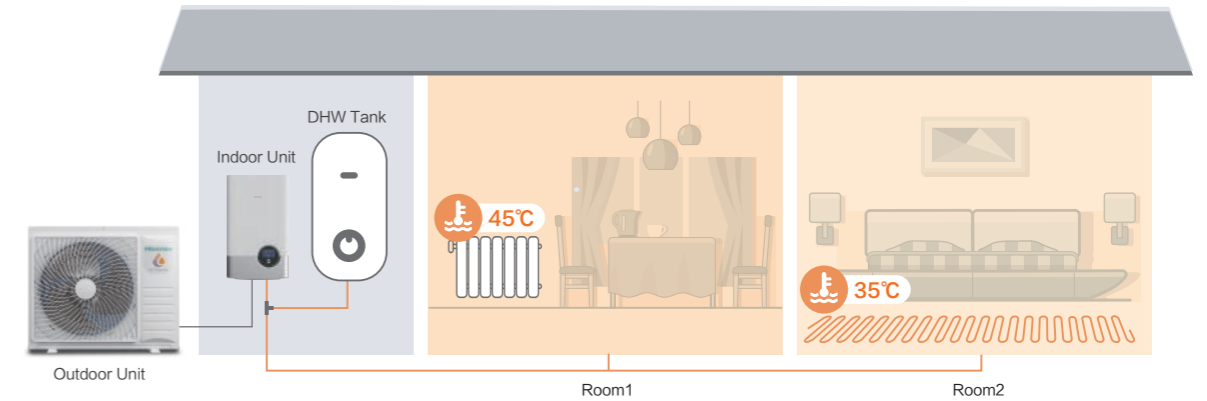
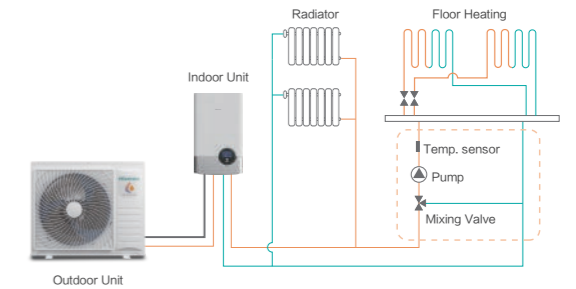

Low Noise Operation

Low Noise Mode

The air to water heat pump system can work in low-noise operation mode for optimal user comfort, which can be achieved just by one touch in the controller or through the setting of input/output. Max.8 dB(A) can be reduced during this mode.

Night Shift Mode

Under the night shift mode, the operation period can be set according to users' demand freely. The sound pressure level can be reduced to 35dB(A)*.

All these settings can be achieved in the controller or through the setting of input/output.

*Take the unit AHW-044HCDS1 as an example.

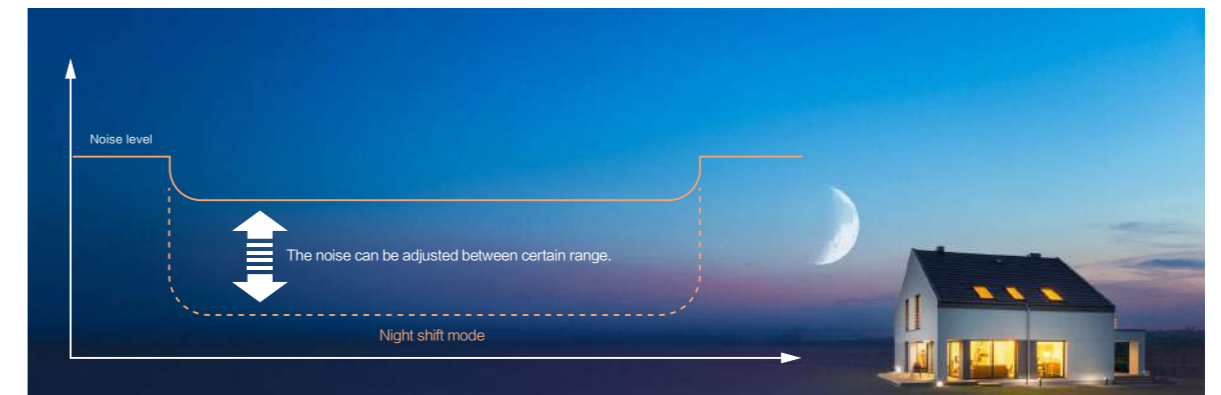



Swimming Pool Heating

Hi-Therma heat pump system can also achieve heating swimming pools. When the swimming pool operation is activated, the hot water will go into the swimming pool heat exchanger, allowing to heat the swimming pool water temperature to a comfortable water temperature between 24 and 33°C.

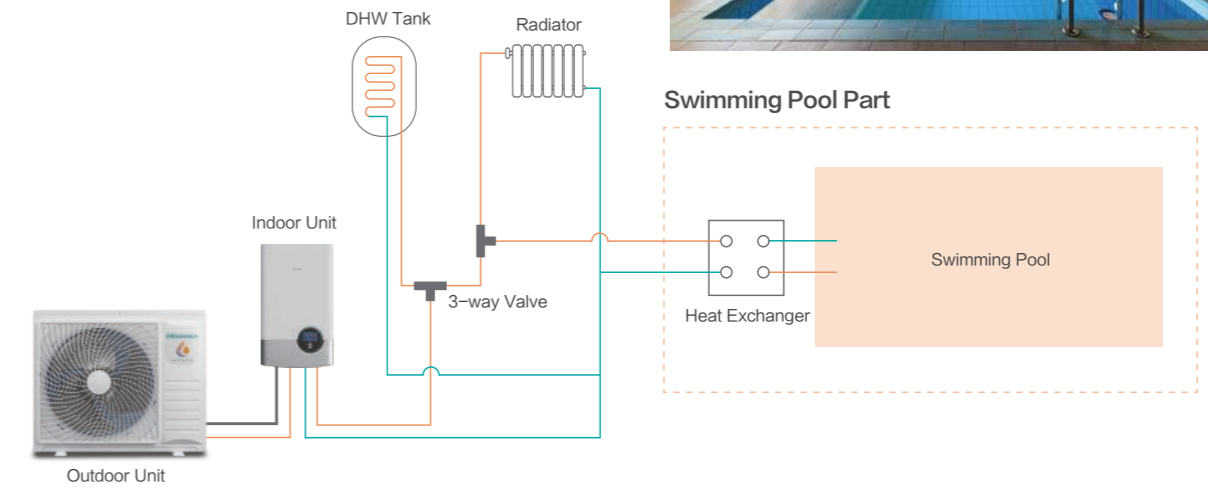

Up to 7 Rooms with Independent Temperature Control

In one Hi-Therma system, the temperature of up to 7 rooms can be independently controlled, through installing temperature sensors or room thermostats in the rooms, satisfying the diverse needs of customers.

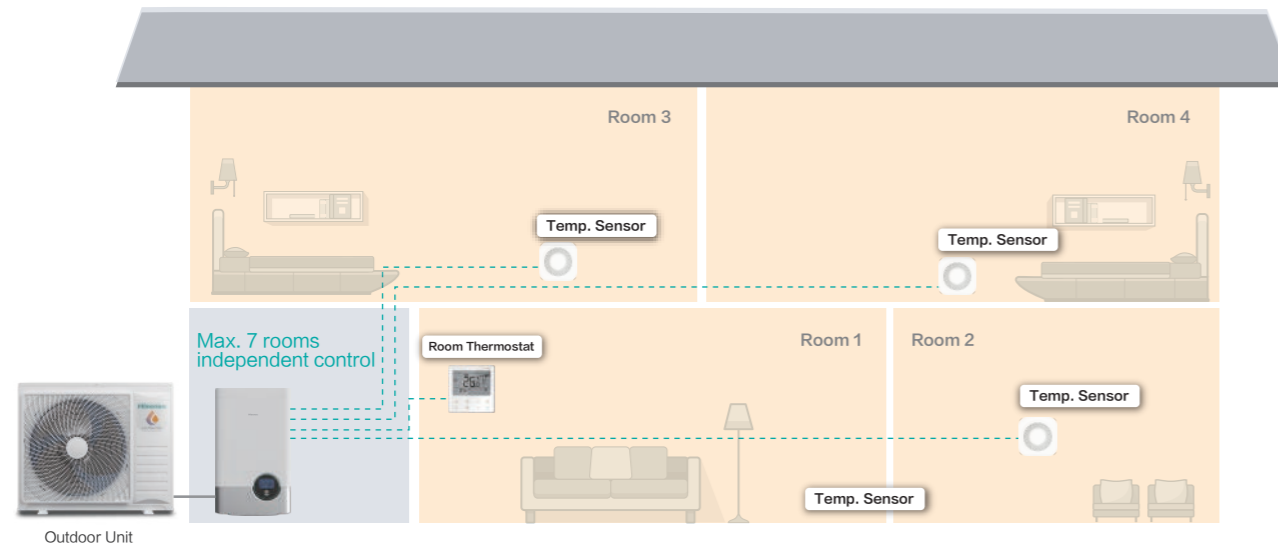

Note: In one Hi-Therma system, up to 2 room thermostats and max. 6 wall mounted temp. sensors can be connected.

Screed Drying Function

Hi-Therma air to water heat pump unit has an automatic program for drying out the screed during the construction of a house with the floor heating underfloor. The screed drying process lasts for 7 days. In the first three days, the system operates with the outlet water temperature of 25 °C, and in the next four days, the system operates with the presetting maximum outlet water temperature.

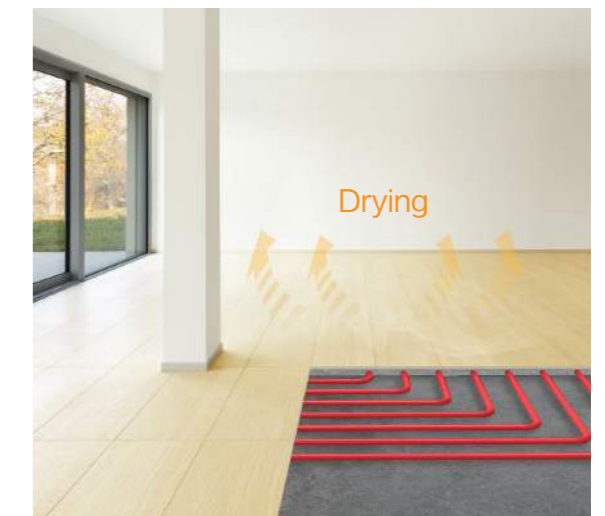
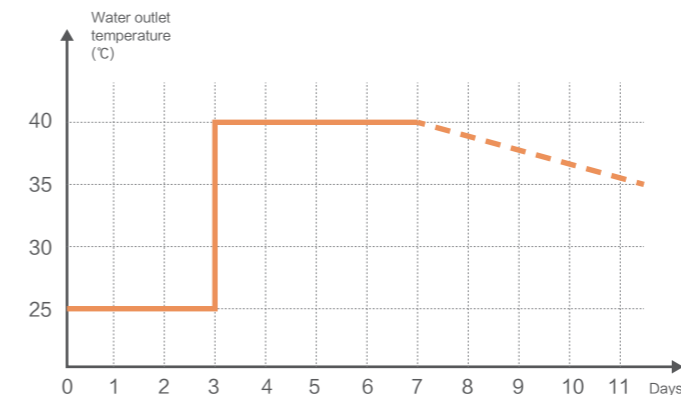

High Intelligence

All along, Hisense has demonstrated our core quintessence to the world: Advanced technology, innovative ideas and the pursuit of excellent user experience. Hisense's brand genes—Genuine, Gentle Generous, have always interpreted all our products and promote us to create a better brand experience. Relying on the Beauty, Symmetry, Unity design style, Hisense integrates elements of individuality and balance in various places such as product shape, outline and trademark. Changes and upgrades can be seen everywhere, whether it is the position of buttons, the layout of display screen or the composition of components.

- Innovative streamlined appearance, exquisite, beautiful, and high integration.
- High-contrast high-definition color interface, bringing more intuitive and rich visual experience.
- Multiple control functions, bringing excellent human-computer interaction experience.



Premium design combines refinement and simplicity

We believe aesthetics should be combined with performance, from pattern to radian coordination, to embody the aesthetic meaning of "Square and Circle" in product design, and to deduce the balance of product appearance and the consistency of pleasure.

Energy consumption management

The energy consumption can be display intuitively in the controllers for precise energy management.

Powerful three-level management system

All the heat sources, water cycles and individual rooms can be controlled through one controller.

Stylish Controller in Indoor Unit

Excellent human-computer interaction experience

The indoor unit has a built-in large colorful screen wired controller, which can be easily operated through the knob and the buttons, and all water cycles and rooms can be configured separately. The main interface can intuitively displays the settings of each water cycles and the current water temperature in real time. The LED light strip around the wire controller can intuitively indicate the current operating mode.

Light strip

The intuitive light strip shows you in real time the status of your system.

Blue: cooling mode or defrost mode.
Yellow: heating mode.
Orange: domestic hot water mode.
Red: malfunction



Quick access

Quick access to frequent settings, including six items – lock, DHW boost, holiday, quiet mode, auto heat, night-shift mode. All these functions can be activated according to users' need.

Fluency of knob operation

All the operations can be accessed through the knob smoothly.

High-resolution colorful screen

The HD colorful screen delivers stunning and clear visual reference, enabling excellent user experience.

Proper interface zones

There are four functional zones, Cycle 1, Cycle 2, DHW, SWP. Each zone has intuitive parameter display, easy to check and set.



Easy operation

Just rotate the knob to quickly go through all the functions, no need to click other buttons, convenient and fluently.

Quickly confirm the selection

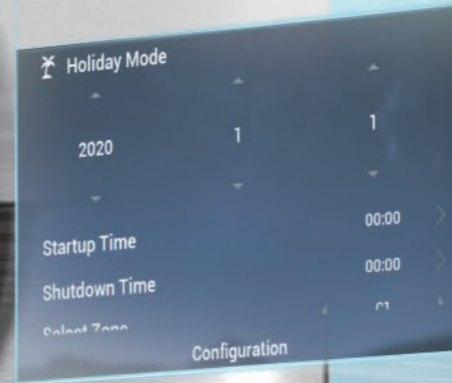

Energy consumption display

Energy data can be viewed easily, including annual energy data, monthly energy data, daily energy data, which will help users to do effective energy management.

General Features

- ◆ Installation Wizard with easy setting for all site configuration
- ◆ Support 10 languages(EN, DE,FR, PL, etc.)
- ◆ Direct visualization of energy consumption and running capacity
- ◆ Centralized control for different water cycles and individual control for rooms
- ◆ Alarm code and advanced parameter display, convenient for maintenance
- ◆ Weekly Timer and Holiday mode support.
- ◆ ECO/ Quiet/ Night shift mode fit for different user needs.

Installation Wizard–Quick to configure

When commissioning for the first time, the installation wizard will appear, and the users can make a smooth step-by-step configuration.



Colorful Touch Controller

Standard for Monobloc and optional for split



Centralized control of different cycles

Independent control of rooms

Sliding Interface

By sliding the screen left and right, quick switching between different interfaces can be realized.

HSXM-FE01

- ◆ Sleek and elegant design
- ◆ Compact, measures only 90 × 90mm
- ◆ Intuitive touch-button control

General Features

- ◆ Installation Wizard with easy setting for all site configuration
- ◆ Support 10 languages(EN, DE,FR, PL, etc.)
- ◆ Direct visualization of energy consumption and running capacity
- ◆ Centralized control for different water cycles and individual control for rooms
- ◆ Alarm code and advanced parameter display, convenient for maintenance
- ◆ Weekly Timer and Holiday Mode support.
- ◆ ECO/ Quiet/ Night shift mode fit for different user needs.
- ◆ Suitable for a variety of installation methods, either exposed or concealed
- ◆ Physical button at the bottom for easy on/off and reset



Sliding Adjusting

The temperature can be adjusted smoothly and quickly by sliding the semicircle, especially for large temperature ranges adjustment.

There is a physical button at the bottom, easy on/off and reset, and don't affect the aesthetics due to its hidden design.

Physical Button

Themes Setting

There are three themes in total, Day, Night and Auto, which can apply to different scenarios at different time, delivering a comfortable and balanced interface display.

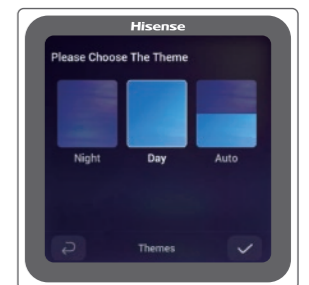

Easy Installation

During the excelsior product design, we give full consideration to the convenience of installation. Thanks to the hanging panel, it's very convenient to install and disassemble. Besides, there is a built-in slot, flexible for wires routing.



Room Thermostat

It can not only set the rooms' temperature, but also accurately link with indoor unit, to feedback the room's load change in real time, ensuring comfortable indoor temperature and high-efficiency operation.



HSXE-VC04

- ◆ Sleek and elegant design
- ◆ Compact, measures only 86 × 86mm
- ◆ Intuitive touch-button control

General Features

- ◆ Compact body and stylish appearance
- ◆ Convenient room temp. & DHW setting
- ◆ Flat backboard, easy-to-install
- ◆ ECO/DHW boost/Timer(0.5-24h)

One-button Switch to DHW Setting

Users can switch to the domestic hot water mode setting with one touch to realize the control of the water system, which is very convenient, no need to do the setting in other controllers.

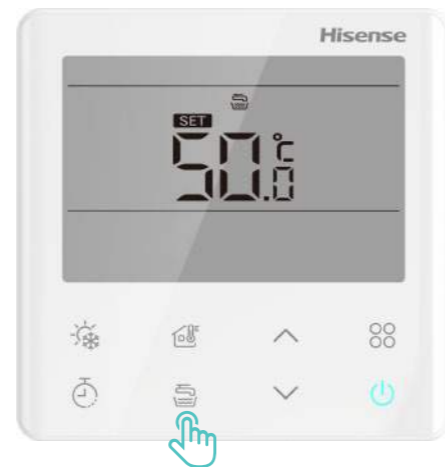

Smart APP Control

Hisense Smart APP control is for those who live their life on the go and who want to manage their heating system at anytime and anywhere.

How it works

After connecting the Hi-Mit adapter to the internet by wireless or wired LAN, the users can control the Hi-Therma system just using a phone anytime and anywhere, achieving operate all the functions through the app.

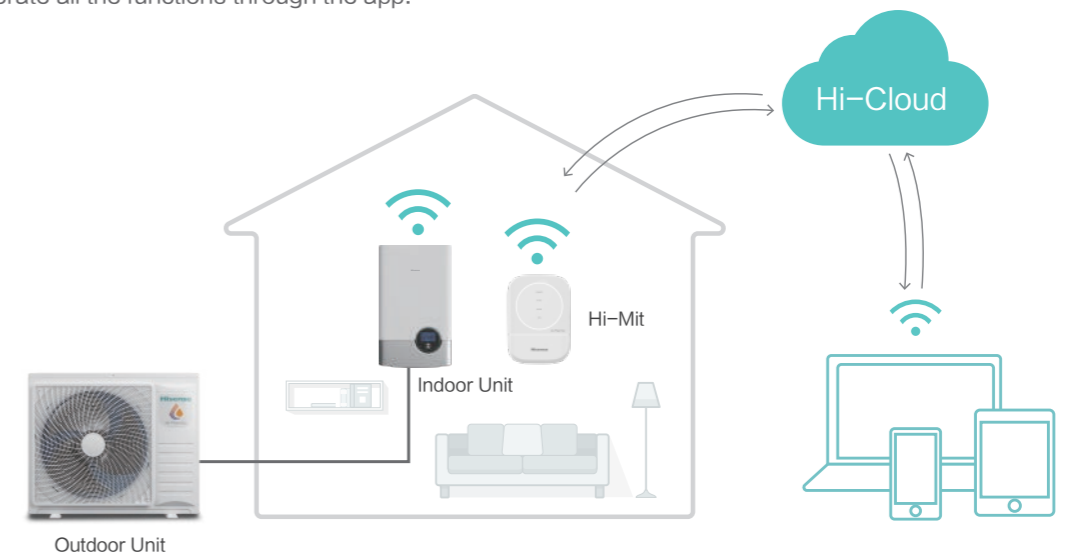



- ◆ Stylish appearance
- ◆ Compact body
- ◆ Supporting OTA update



Simple and convenient operation

- ◆ On/Off
- ◆ The temp. setting of rooms, domestic hot water and water cycles
- ◆ Energy management
- ◆ Online repair report
- ◆ 14 languages available
- ◆ Multiple scenes setting



Specifications

Model	Power Supply	Max. Current	Power Input	Dimension	Net Weight
HCCS-H64H2C1M#01	DC 12V	1A	2.4W	91 × 117 × 31mm	0.14kg



Energy management

Hi-Mit provides intelligent energy management, which supporting daily, weekly and monthly electricity data viewing, and energy saving mode setting accordingly. It greatly facilitates the energy management.



Easy Installation and Maintenance



Flexible Refrigerant Piping Design

Long piping length enables flexible design and easy installation.

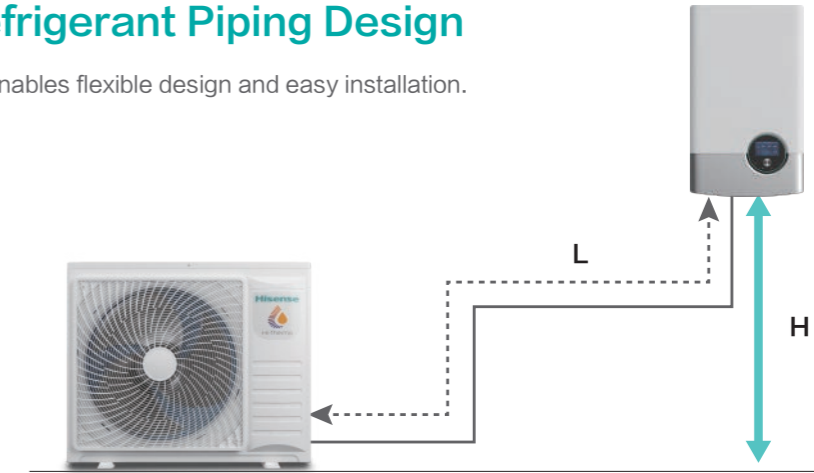

Max. piping length L: 45(50*)m Max. height difference H: 20/30*2m

*1 When the piping length is 50m, the ambient temperature of the outdoor unit shall be $\geq 10^{\circ}\text{C}$, and the refrigerant charge of the unit shall be less than the max. refrigerant charge allowed by the unit.

*2 When the outdoor unit is higher than the indoor unit, the max. height difference is 30m, otherwise is 20m.

Convenient Maintenance for the Indoor Unit

The position of the components in indoor unit has been fully optimized, and the electrical box can be rotated 88° , which facilitates the maintenance of the parts behind the electrical box, and greatly simplifies the maintenance. Besides, there is a hook on the outer sheet metal of the electrical box, and the controller can be conveniently hung during on-site maintenance.

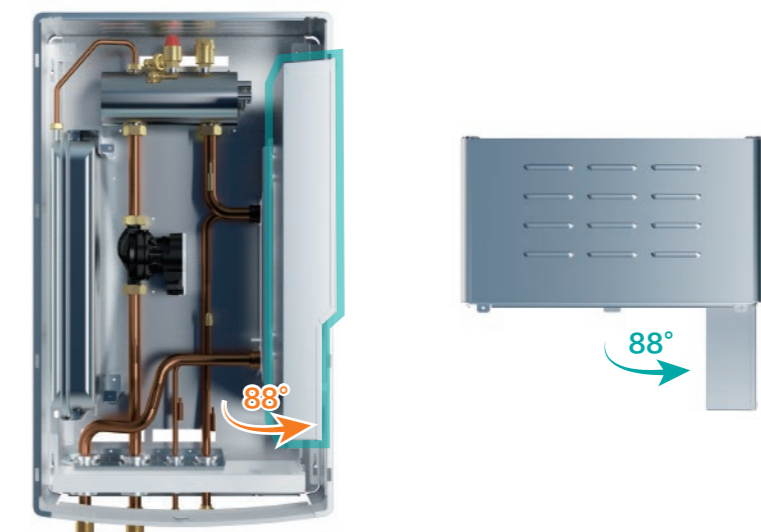

Hi-Checker

Intelligent service tool, improve your service

Hi-Checker is a plug and play service tool, with which service engineers can access the system and monitor operation status or data, very convenient for system communication and maintenance. Besides, it features cloud-based management, easy to access operation status remotely.

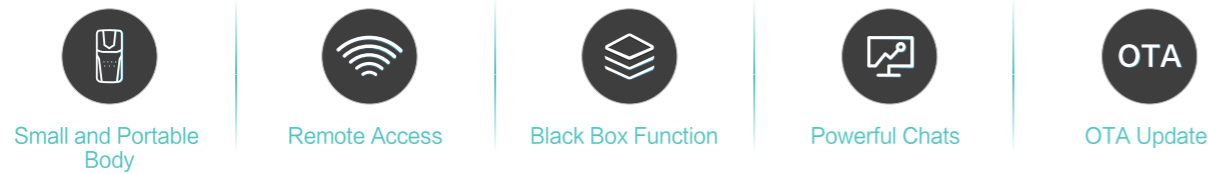

Different water cycles in multiple rooms control

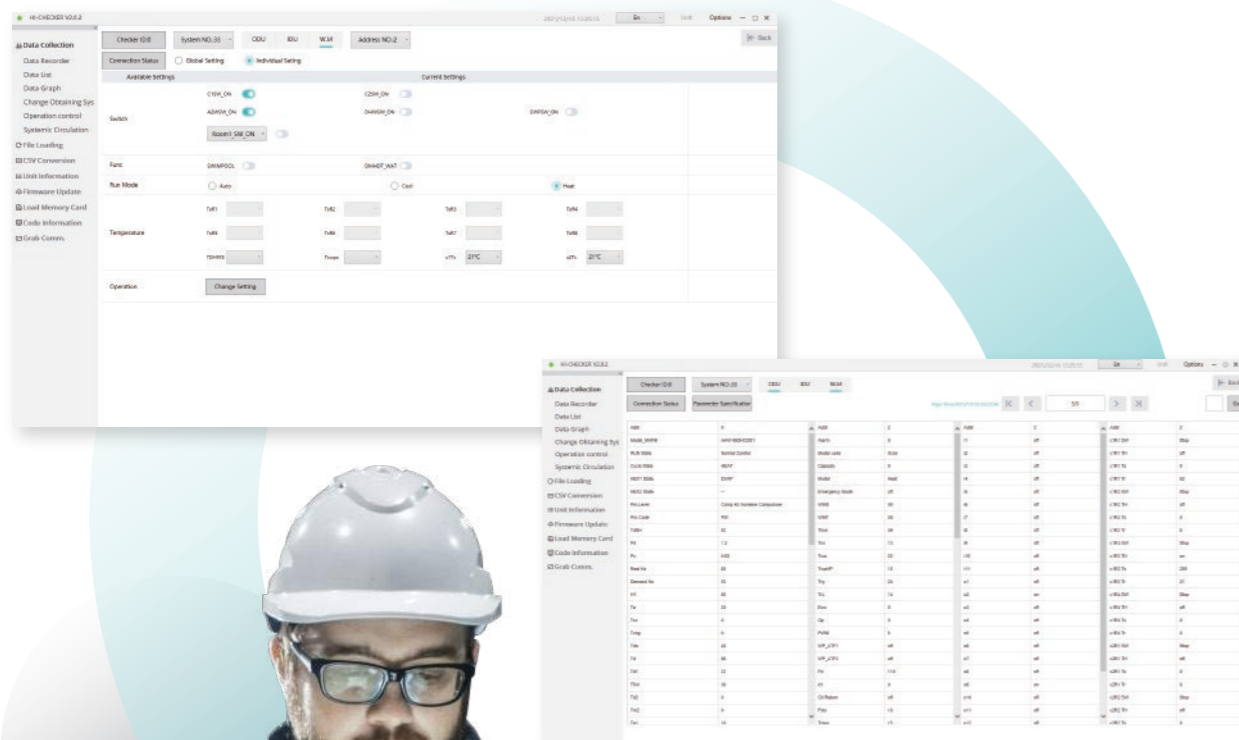

Up to 130 parameters of the water system can be displayed intuitively.



Easy to use

- ◆ Compact size which allows high portability and space saving.
- ◆ Capable to slot in a 32G memory card for data collection and storage. Also the memory card and card reader are standard with Hi-Checker.
- ◆ Multiple choices of power supply types. It can be powered by the standard adapter (DC 5V), computers or power banks.
- ◆ Support OTA update, ensuring the software is always up to date.



Easy to access

4 ways to access the operation data

- ◆ Conventional connection type. The simplest and reliable way by just connecting the Hi-Checker to your computer directly through USB.
- ◆ Internet connection type. Be connected to a stable Wi-Fi signal to achieve operation data and status monitoring anytime and anywhere.
- ◆ Hotspot connection type. Be connected to a temporary hotspot signal from the smartphone, allowing the Hi-Checker to remotely monitor the operation data when there is no stable Wi-Fi signal on site.
- ◆ SD card storage type. Hi-Checker equipped with SD card can be connected to the air conditioning system all the time, so that all the operation data can be stored in the card for later analysis.

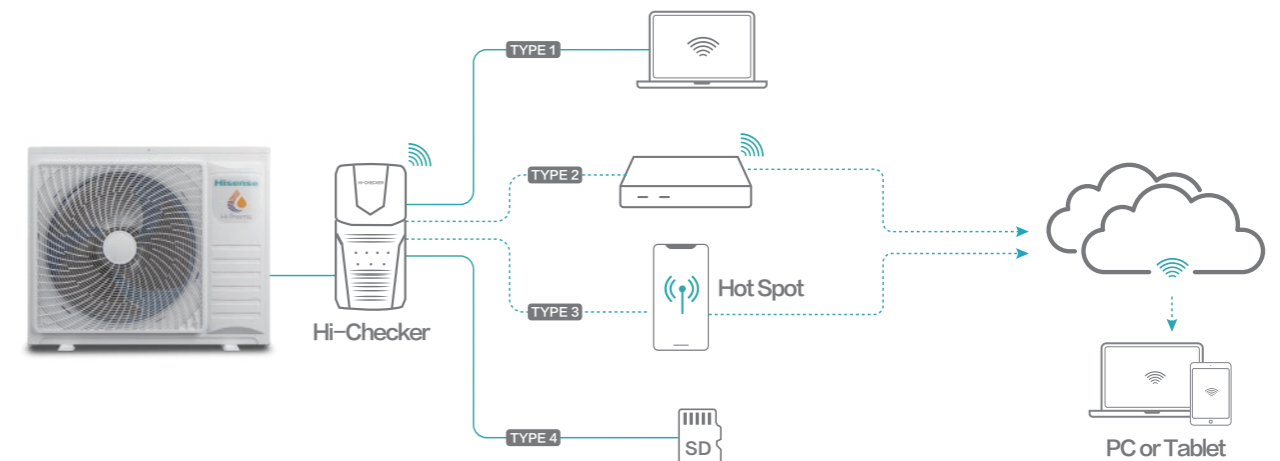

Specifications

Model	Size (L × W × H) mm	Net Weight (g)	Power Supply
HCCS-H64H2C2M	138 × 68 × 28	130	5V=500mA

Split

Hi-Therma Split unit is an air to water heat pump system that indoor unit and outdoor unit are separated. The indoor unit including plate heat exchanger, expansion tank, water pump ect. is located in the room, which can avoid water freezing problems.

High Efficiency and Excellent Performance

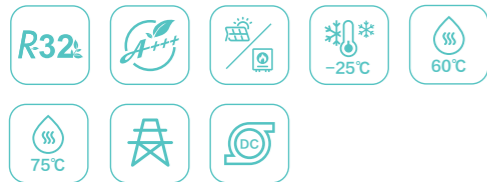

User Convenience



High Intelligence



Easy Installation and Maintenance



Outdoor Unit



Indoor Unit

Indoor Unit

Indoor Unit

- Stylish appearance
- Compact design
- Integrated panel
- Intuitive control interface
- Easy to hang to the wall

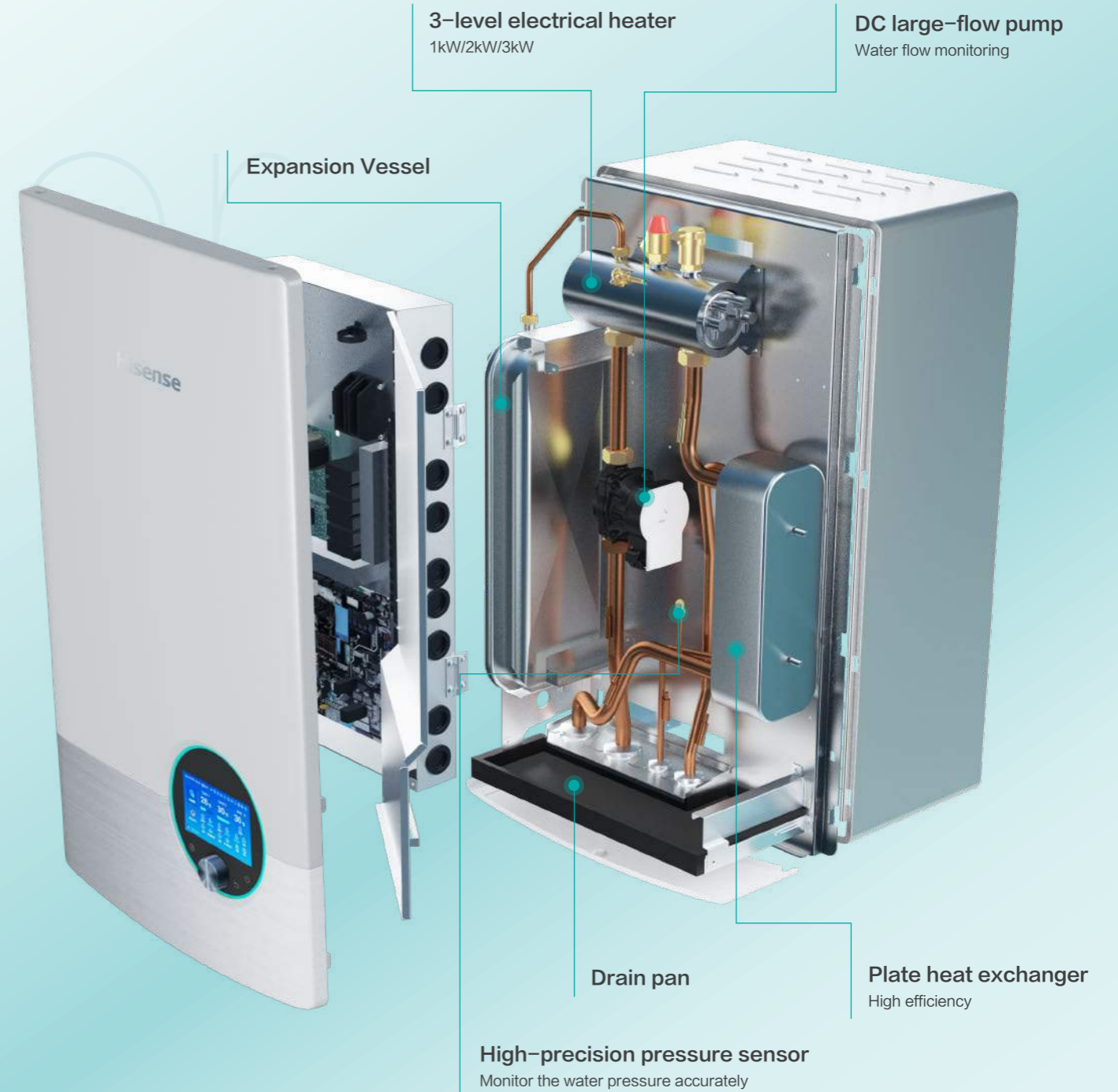



041-K021-01/02



Outdoor Unit Specification

Dimensions

Model				AHW-044HCDS1	AHW-060HCDS1	AHW-080HCDS1	
Power Supply				AC 1Φ, 220-240V/50Hz			
Heating Operation	OAT (DB/WB) 7/6°C	IWT/OWT 30/35°C	Capacity(Min./Nom./Max.)	1.85 / 4.40 / 7.00	1.95 / 6.00 / 8.90	2.10 / 8.00 / 11.0	
			COP (Nom.)	5.10	5.00	4.90	
		IWT/OWT 47/55°C	Capacity (Nom./Max.)	4.40 / 6.00	6.00 / 7.50	8.00 / 9.00	
	OAT (DB/WB) -7/-8°C		COP (Nom.)	3.00	3.05	2.80	
		IWT/OWT 30/35°C	Capacity (Nom./Max.)	4.40 / 5.00	5.30 / 5.90	5.80 / 7.30	
		IWT/OWT 47/55°C	COP (Nom.)	3.26	3.16	3.14	
Cooling Operation	OAT (DB/WB) 35/-°C	IWT/OWT 12/7°C	Nominal Capacity	4.40	5.00	6.00	
			EER	3.90	3.70	3.60	
		IWT/OWT 23/18°C	Nominal Capacity	5.60	6.00	7.00	
	Space Heating	Water Outlet 35°C		EER	5.60	5.60	5.10
				SCOP	5.00	4.93	4.92
				Seasonal Space Heating Efficiency(ηs)	197	194	194
Water Outlet 55°C		Energy Rating	A+++	A+++	A+++		
		SCOP	3.23	3.33	3.42		
		Seasonal Space Heating Efficiency(ηs)	126	130	134		
Sound Pressure*1	Normal Mode (Heating/Cooling)		Energy Rating	A++	A++	A++	
			SCOP	47/47	48/47	50/47	
			Low Noise Mode (Heating/Cooling)	39/39	42/42	43/43	
Sound Power	Normal Mode (Heating/Cooling)		dB(A)	35/35	38/38	39/39	
			dB(A)	61/61	62/61	64/61	
Fan	Condenser Fan Quantity		—	1	1	1	
			Air Flow Rate	m³/h	2700	2700	2700
Max. Running Current			A	9.8	12	16.8	
Recommended Fuse			A	16	16	20	
Outer Dimensions	H × W × D		mm	750 × 900 × 340	750 × 900 × 340	750 × 900 × 340	
Packing Dimensions	H × W × D		mm	807 × 1022 × 445	807 × 1022 × 445	807 × 1022 × 445	
Net Weight			kg	49.5	49.5	50.5	
Gross Weight			kg	53.5	53.5	54.5	
Refrigerating Installation	Refrigeration Charge	Type	—	R32			
		Before Shipment	kg	1.23	1.23	1.26	
	Piping	Gas Pipe	mm	φ12.7	φ12.7	φ15.88	
			in.	1/2	1/2	5/8	
		Liquid Pipe*2	mm	φ6.35 (φ9.53)	φ6.35 (φ9.53)	φ6.35 (φ9.53)	
			in.	1/4 (3/8)	1/4 (3/8)	1/4 (3/8)	
	Min. Piping Length		m	3			
	Max. Chargeless Piping Length		m	10			
Max. Piping Length		m	40	40	45 (50*3)		
Height difference between ODU and IDU	ODU is Higher	m	30	30	30		
	IDU is Higher	m	20	20	20		
Operation Range	Heating	Outdoor Ambient Temperature	°C(DB)	-25~35			
		Outlet Water Temperature	°C	15~60			
	DHW	Outdoor Ambient Temperature	°C(DB)	-25~40°C			
		Outlet Water Temperature	°C	30~55(75*4)			
	Cooling	Outdoor Ambient Temperature	°C(DB)	5~46			
		Tank Water Temperature	°C	5~22			

Note:

*1:The above noise values are measured in the anechoic chamber without reflected echo, therefore the impact of the reflected echo must be taken into consideration at the scene.

*2:The refrigerant gas and liquid piping size are different between outdoor and indoor unit, so refrigerant pipe adapters are required. Please refer to the installation manual for detailed information.

*3:The ambient temperature of the outdoor unit shall be ≥ 10°C, and the refrigerant charge of the unit shall be less than the maximum refrigerant charge allowed by the unit.

*4:When there is a DHW electric heater mounted in the DHW tank, the setting temperature can reach 75°C.

The nominal heating and cooling capacities are based on the EN 14511 standard: Piping length 7.5 meters; Piping lift 0 meters.

OAT: Outdoor ambient temperature; IWT: Inlet water temperature; OWT: Outlet water temperature.

Unit: mm

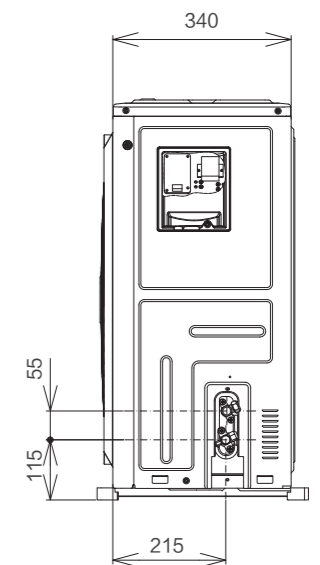
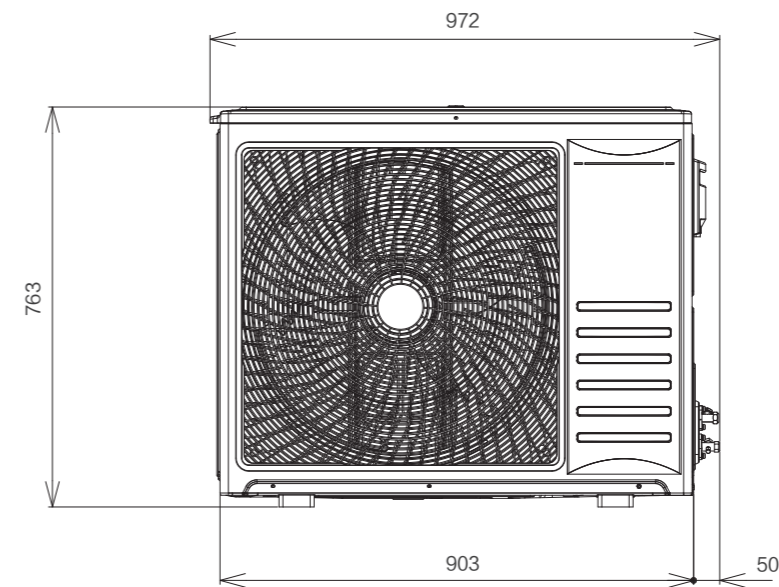
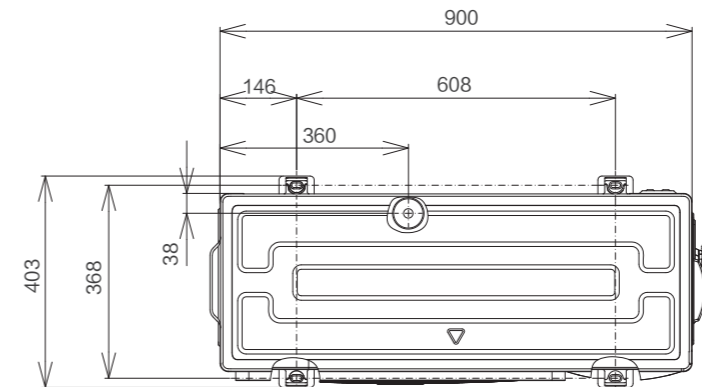



041-K021-01/02



Indoor Unit Specification

Dimensions

Model		AHM-044HCDSAA	AHM-060HCDSAA	AHM-080HCDSAA	
Power Supply	—	AC 1Φ, 220~240V/50Hz			
Nominal Water Flow	IWT: 30°C / OWT: 35°C ΔT: 5°C	m³/h	0.77	1.03	1.38
Min. Water Flow		m³/h	0.50	0.60	0.60
Pump Available Pressure		kPa	62	47	32
A Class Pump	Number of speeds	—	Various speed		
	Max. Input Power	W	50	50	50
Sound Pressure		dB(A)	28	28	28
Sound Power		dB(A)	42	42	42
Max. Running Current		A	16(31*1)		
Recommended Fuse		A	20(40*1)		
Outer Dimensions with connections	Height	mm	890 × 520 × 419	890 × 520 × 419	890 × 520 × 419
Packing Dimensions	Height	mm	419 × 1160 × 650	419 × 1160 × 650	419 × 1160 × 650
Net Weight		kg	43.5	43.5	44.5
Gross Weight		kg	48.5	48.5	49.5
Refrigerating Installation	Connection Type	—	Flare nut connection		
	Gas Pipe	mm	Φ 12.7	Φ 12.7	Φ 15.88
		in.	1/4	1/4	5/8
	Liquid Pipe*2	mm	Φ 6.35 (Φ 9.53)	Φ 6.35 (Φ 9.53)	Φ 6.35 (Φ 9.53)
in.		1/4 (3/8)	1/4 (3/8)	1/4 (3/8)	
Water Pipes Connection	Connection type	—	Screwed connection		
	Shutdown valves	mm (in.)	G 1" (male) - G 1" (male)		
	Inlet pipe diameter	mm (in.)	G 1" (female)		
	Outlet pipe diameter	mm (in.)	G 1" (female)		

Note:

*1: The value with * is the data when electric heater is working.

*2: The refrigerant gas and liquid piping size are different between outdoor and indoor unit, so refrigerant pipe adapters are required.

Please refer to the installation manual for detailed information.

Unit: mm

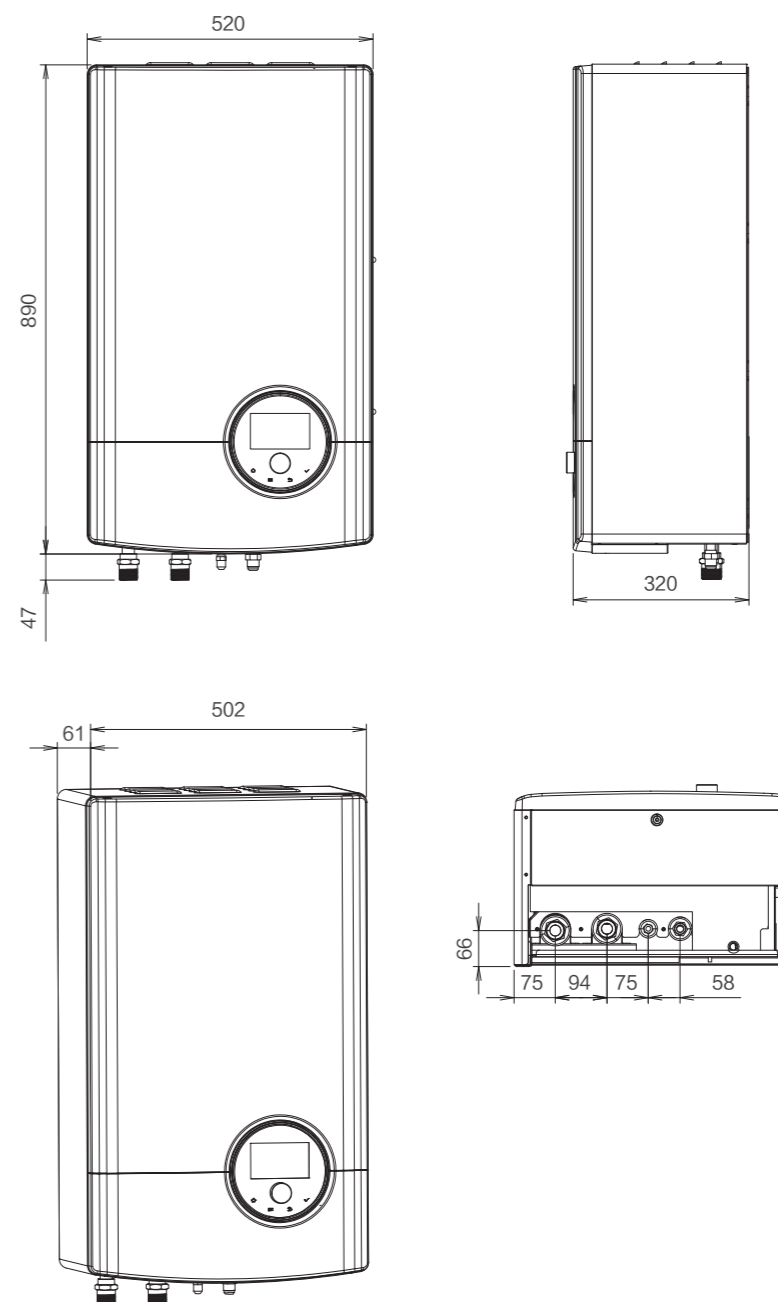

Monobloc

Hi-Therma Monobloc unit is an air to water heat pump system that indoor unit and outdoor unit are combined as one module, which ensures all functions are achieved with a single outdoor unit. Therefore, there is no need for refrigerant piping work since Monobloc unit located outside is connected only to water piping. Further, hydronic components such as plate heat exchanger, expansion tank and water pump are included in the package.

High Efficiency and Excellent Performance



User Convenience



High Intelligence



Easy Installation and Maintenance



Simplified Installation

Hi-Therma Monobloc unit featuring all-in-one design allows easy installation without additional refrigerant piping work and refrigerant charge. Only the connection of water pipes is required on site, which greatly simplifies the on-site installation work.

Water side items included in the Monobloc

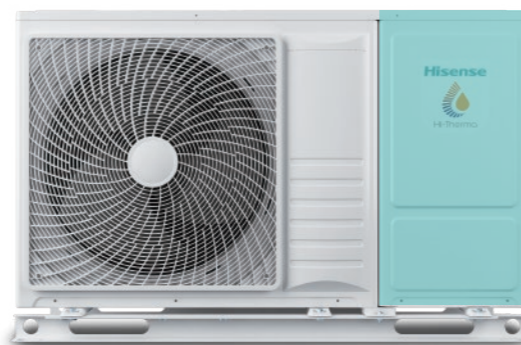
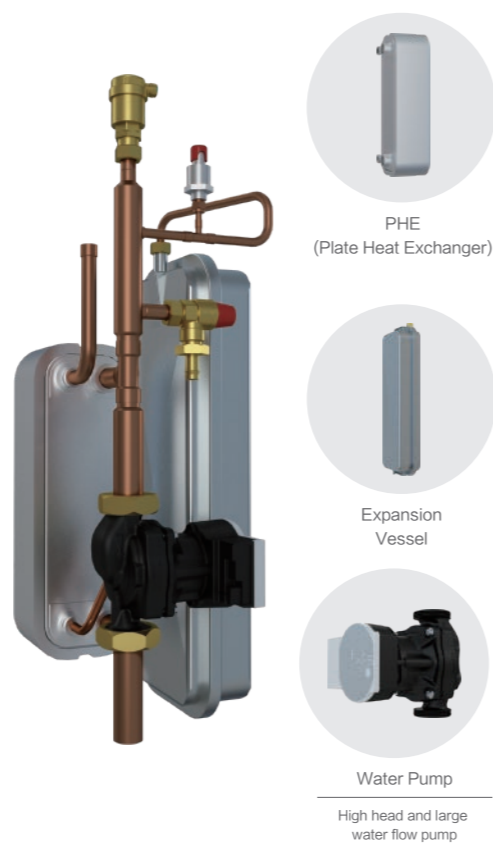

Outdoor Unit Specification

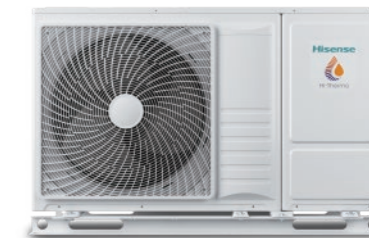

Model					AHZ-044HCDS1	AHZ-080HCDS1	
Power Supply					AC 1 Φ, 220-240V/50Hz		
Heating Operation	OAT (DB/WB) 7/6°C	IWT/OWT 30/35°C	Capacity (Min./Nom./Max.) COP (Nom.)	kW	1.85 / 4.40 / 7.00 5.10	2.10 / 8.00 / 11.0 4.90	
		IWT/OWT 47/55°C	Capacity (Nom./Max.) COP (Nom.)	kW	4.40 / 6.00 3.00	8.00 / 9.00 2.80	
		OAT (DB/WB) -7/-8°C	IWT/OWT 30/35°C	Capacity (Nom./Max.) COP (Nom.)	kW	4.40 / 5.00 3.26	5.80 / 7.30 3.14
	Cooling Operation	OAT (DB/WB) 35/-1°C	IWT/OWT 12/7°C	Nominal Capacity EER	kW	4.40 4.00	6.50 3.35
			IWT/OWT 23/18°C	Nominal Capacity EER	kW	5.60 5.60	7.00 5.10
			SCOP	-	5.17	5.00	
Space Heating	Water Outlet 35°C	Seasonal Space Heating Efficiency(ηs)	%	204	197		
		Energy Rating	-	A+++	A+++		
	Water Outlet 55°C	SCOP	-	3.47	3.50		
		Seasonal Space Heating Efficiency(ηs)	%	136	137		
Sound Pressure*1	Normal Mode (Heating/Cooling)		dB(A)	47/47	50/47		
	Low Noise Mode (Heating/Cooling)		dB(A)	40/40	43/43		
	Night Shift Mode (Heating/Cooling)		dB(A)	36/36	39/39		
Sound Power	Normal Mode (Heating/Cooling)		dB(A)	61/61	64/61		
Fan	Condenser Fan Quantity		-	1	1		
	Air Flow Rate		m³/h	2700	2700		
Max. Running Current				A	10.53	17.53	
Recommended Fuse				A	16	20	
Outer Dimensions	H × W × D		mm	815 × 1270 × 340	815 × 1270 × 340		
Packing Dimensions	H × W × D		mm	890 × 1440 × 440	890 × 1440 × 440		
Net Weight				kg	88	88	
Gross Weight				kg	102	102	
Refrigerating Installation	Refrigeration Charge	Type		-	R32		
		Before Shipment		kg	1.17	1.21	
Operation Range	Heating	Outdoor Ambient Temperature	°C(DB)	-25-35			
		Outlet Water Temperature	°C	15-60			
	DHW	Outdoor Ambient Temperature	°C(DB)	-25-40			
		Outlet Water Temperature	°C	30-55(75*)			
	Cooling	Outdoor Ambient Temperature	°C(DB)	5-46			
		Tank Water Temperature	°C	5-22			
Nominal Water Flow	IWT: 30°C / OWT: 35°C ΔT: 5°C		m³/h	0.77	1.38		
Min. Water Flow				m³/h	0.5	0.6	
Pump Available Pressure				kPa	84	74	
A Class Pump	Number of Speeds		-	Various speed			
	Max. Input Power		W	87	87		
Water Pipes Connection	Connection Type		-	Screwed connection			
	Shutdown Valves		mm (in.)	G 1" (male) - G 1" (male)			
	Inlet Pipe Diameter		mm (in.)	G 1" (female)			
	Outlet Pipe Diameter		mm (in.)	G 1" (female)			

Note:

*1: The above noise values are measured in the anechoic chamber without reflected echo, therefore the impact of the reflected echo must be taken into consideration at the scene.

*2: When there is a DHW electric heater mounted in the DHW tank, the setting temperature can reach 75°C.

OAT: Outdoor ambient temperature; IWT: Inlet water temperature; OWT: Outlet water temperature

The nominal heating and cooling capacities are based on the EN 14511 standard: Piping length 7.5 meters; Piping lift 0 meters.

OAT: Outdoor ambient temperature; IWT: Inlet water temperature; OWT: Outlet water temperature.

Dimensions

Unit: mm

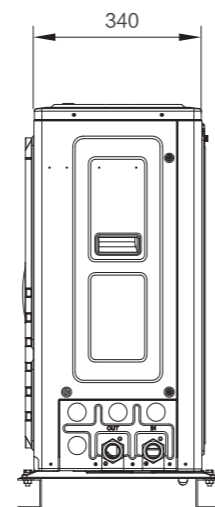
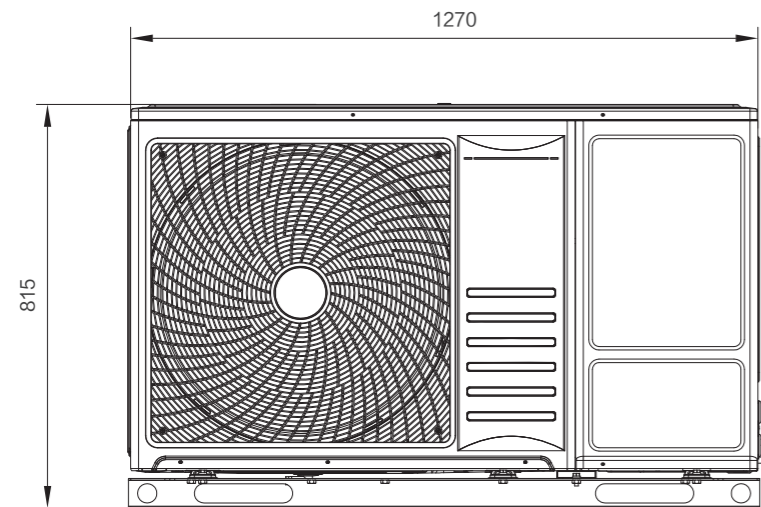
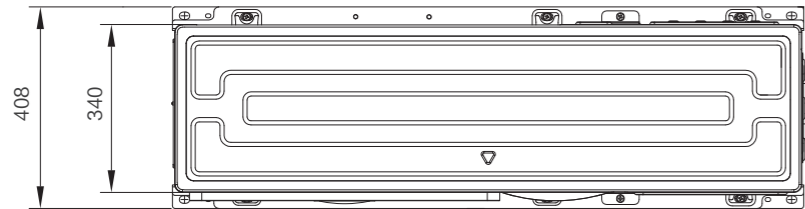





Hi-Aquasmart Series

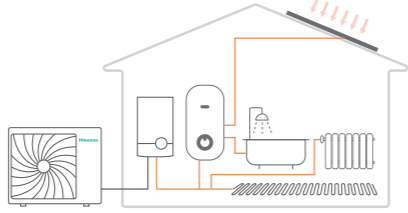

Product Lineup Overview

Series	Hi-Aquasmart
Type	Split
Diagram	
Refrigerant Type	R410A
Line-up	12.0/14.0/16.0kW
Application	
Energy Label Space Heating 35°C	
Benefit	<ul style="list-style-type: none"> Enhanced vapor injection Strong heating capacity under low ambient temp. Assembly various heat sources High-efficiency water pump



High-efficiency Air to Water Heat Pump 3 in 1 Solution

Hisense air to water heat pump system absorbs the free energy from outside atmosphere, which only consume less electricity to generate more heat energy. Hi-AquaSmart Series have better performance, high efficiency, high energysaving, less CO₂ emissions. This Series can be easy to install on new building or existing building. High efficient Hisense air to water heat pumps can obviously reduce the energy consumption of the building. In addition, it can work with a traditional heating source, such as oil or gas boiler.

Enhanced Vapor Injection

Hisense adopts vapor injection scroll compressor, which provides higher compression ratio, smoother oil supply and lower noise level.

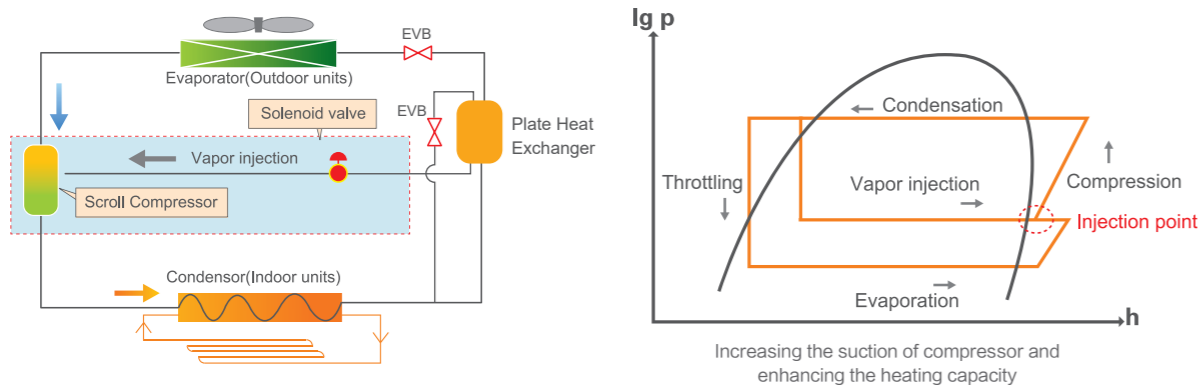

The vapor injection system and stepless inverter technique greatly improve the refrigerant cycle system. It effectively increases refrigerant flow through vapor injecting, thus substantially enhancing the heating capacity.

Less CO₂ Emissions

Heat Pump can significantly reduce CO₂ emissions because it collects free energy from the air, and produces less CO₂.

- ◆ 66% less than Electric Heating
- ◆ 50% less than Oil Heating
- ◆ 30% less than Gas Heating

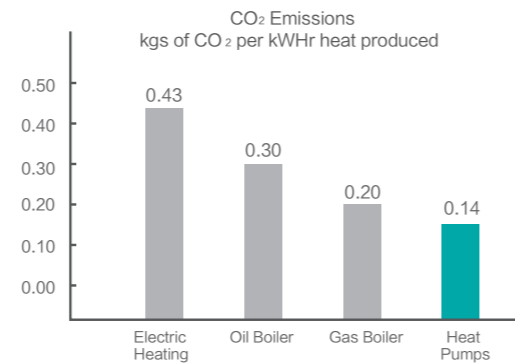

High Efficient Water Pump (DC)

Hi-aquasmart Series is equipped with a high efficient DC(inverter) water pump, which can minimize energy consumption during operating time.

It has a better linear controllable for capacity output and wider adaptability for many application places compared with AC water pump.

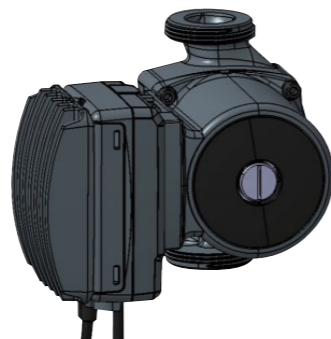

Various Operation Modes

Multiple operation modes are optional to satisfy the personalized use habits of different users.



Economical

Compared to the other heating modes, such as electricity, gas, coal/oil, solar, and so on, the heat pump system is more efficient and the annual cost reduction is obvious.

Average annual running cost

Direct electric heating	100%
Fuel boiler	50%
Gas condensing boiler	45%
Hi-AquaSmart	30%

Strong Heating Capacity Under Low Ambient

Hi-AquaSmart can maintain the strong heating capacity even under low ambient without electrical booster heater. For 14KW model, it can maintain the same nominal capacity at -15° C, and for 16KW model, it can maintain the same nominal capacity at -10° C without electrical booster heater.

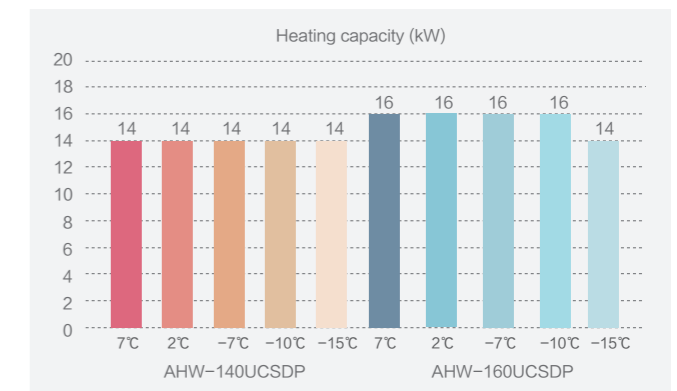

Assembly Various Heat Sources

Hi-AquaSmart is allowed to combine with existing boiler or solar, so undoubtedly Hi-AquaSmart will be the best alternative to traditional boiler system in old building, and also as a hot water back-up solution to the existing boiler. In case that one heating unit was not working due to some unforeseen problem, this system can ensure heating system no stopping.

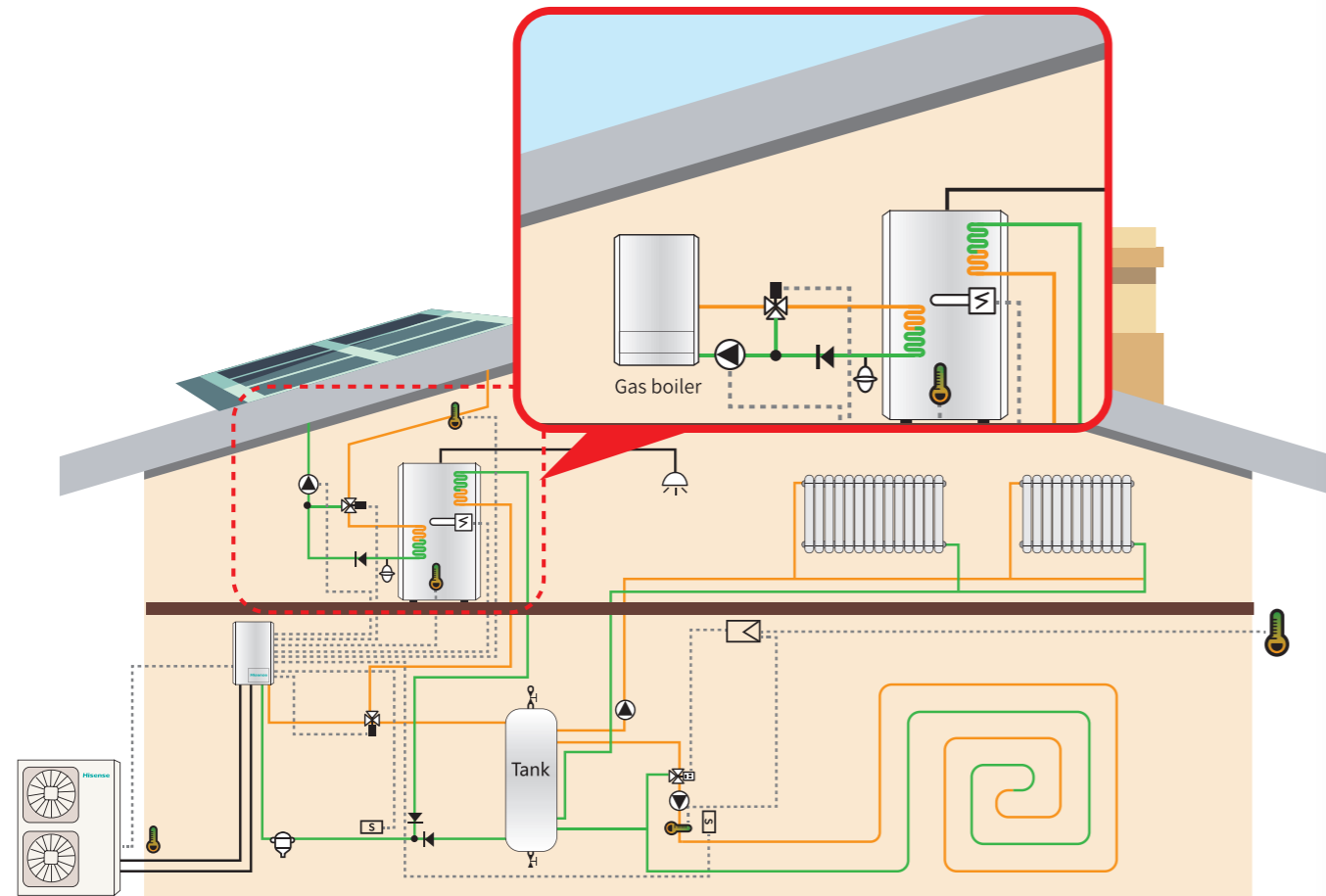

Operation system

- Underfloor heating
- Low temperature radiators
- Domestic hot water
- Hi-aquasmart+solar/boiler(optional)

	Temperature Sensor		Check Valve		Decantation tank
	Security Thermostat		Motorized 2 ways Valve		Expansion tank
	Regulator		Motorized 3 ways Valve		
	Electric Heater				
	Water Pump				

Outdoor Unit Specification



Outdoor unit			AHW-120UCSDP	AHW-140UCSEP	AHW-160UCSEP
Indoor unit			AHM-160UXCSAPA3	AHM-160UXCSAPA3	AHM-160UXCSAPA3
Refrigerant			R410A	R410A	R410A
Power supply			AC1Φ, 220~240V/50Hz		
Compressor			Twin rotary compressor	Scroll compressor with Vapor-injected	Scroll compressor with Vapor-injected
Condition 1 Ta7/6°C LWC35°C (DT=5°C)	Heating capacity	kW	12	14	16
	COP		4.10	4.84	4.74
Condition 2 Ta7/6°C LWC45°C (DT=5°C)	Heating capacity	kW	10.8	12.5	14.8
	COP		3.53	3.70	3.95
Cooling Ta35°C LWE18°C (DT=5°C)	Cooling capacity	kW	10.5	12	13.5
	EER		2.80	2.77	2.53
Dimensions	H × W × D	mm	800 × 950 × 370	1380 × 950 × 370	1380 × 950 × 370
Operation Ambient Range	Heating	°C	-20~35	-20~35	-20~35
	DHW	°C	-20~43	-20~43	-20~43
	cooling	°C	10~43	10~43	10~43
Heating Sound pressure		dB(A)	54	51	52
Cooling Sound pressure		dB(A)	53	50	51

Notes:

The cooling and heating performance in agreement with EN14511.
 Heating condition: Outdoor Air Temperature 7°C DB/6°C DB, Inlet/Outlet water temperature 30°C/35°C.
 Cooling condition: Outdoor Air Temperature 35°C, Inlet/Outlet water temperature 12°C/7°C.
 Piping length:7.5 meter; Piping lift:0 meter



Indoor Unit Specification

Capacity			AHM070UXCSAPA3	AHM-160UXCSAPA3
Power supply			AC1 φ, 220-240V/50Hz	
Heating capacity	kW		7	16
Hot water capacity	kW		7	16
Power input	kW		0.245	0.245
Dimensions	H × W × D	mm	890 × 520 × 320	
Net Weight	kg		55	58
Heat Exchanger			Plate heat exchanger	
Hot water temperature	Heating	°C	15-55	15-55
	DHW	°C	15-55	15-55
	cooling	°C	5-25	5-25
Sound pressure level		dB(A)	33	33
Piping connections	gas	mm	9.53	9.53
	liquid	mm	15.88	15.88
Water pump	type		DC	DC
	brand		Grundfos	Grundfos
Booster heating		kW	3	3

Dimensions

Unit: mm

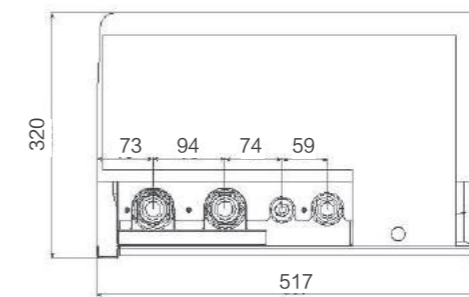

Accessories & Engineering Tools

Accessories



Ambient Temperature Sensor

HC-T-01M

Measure the outdoors ambient temperature in the area where the outdoor unit is installed.

Compatibility: Hi-Therma series



Water Temperature Sensor

HTS-E1000A1

Water temperature sensor for pipeline, tank and hydraulic components

Compatibility: Hi-Therma series



Wall Mount Temperature Sensor

HCT-S01E

Wall mounted room temperature sensor, with communication to heat pump system.

Compatibility: Hi-Therma series



Room Thermostat

HSXE-VC04

Room thermostat for room temperature control, with communication to heat pump system. Compatibility: Split Heat Pump System

Compatibility: Hi-Therma series



3-way Valve

HESE-3W25A

Valve to allow operation in heating/hot water

Compatibility: Hi-Therma series



Colorful Touch Controller

HSXM-FE01

4" colorful touch controller with powerful functions, achieving two cycles setting, DHW setting and SWP setting.

Compatibility: Hi-Therma series

*It's standard for Monobloc and optional for Split. In split system, if this controller is used, the controller built-in the indoor unit should be inactivated.

Engineering Tools

Hi-Therma Designer

Hi-Therma Designer is a specialized program for choosing Hisense ATW heat pump products, enabling an accurate and quick model selection for projects. It's an online tool for quick and easy access, and fully compatible with computer, tablet and smartphone. The user could open and edit the project at any time and anywhere.

◆ User-friendly operation

This program provides a lot of pictures, schemas and explanations. With less input and choice, the user can get the proper selection quickly and easily.

◆ CO₂ emission calculation

The user can calculate the CO₂ emission that can be reduced from conventional heating systems with other energy.

◆ Selection comparison

Through this function, users can compare two different selections for one project, so as to get the best solution.

◆ Report

A professional report with full information and quotation can be output to submit to clients. The user can select the part of full size report to make a short report.

◆ Energy consumption calculation

The software includes the build-in climate history data for hundreds of cities, which enabling easy load calculation. Furthermore, the user can calculate the annual energy consumption and efficiency.

◆ Noise level assessment

The noise level to the closed house, such as neighbor's house, could be assessed with a simulation according to the outdoor unit installation.

◆ Customization of accessories

The installer can input and customize the accessories which is used to buy locally.

<https://www.hitherma-designer.com>

